

# NOVELTIES 2026

Fullfilling Expectations.

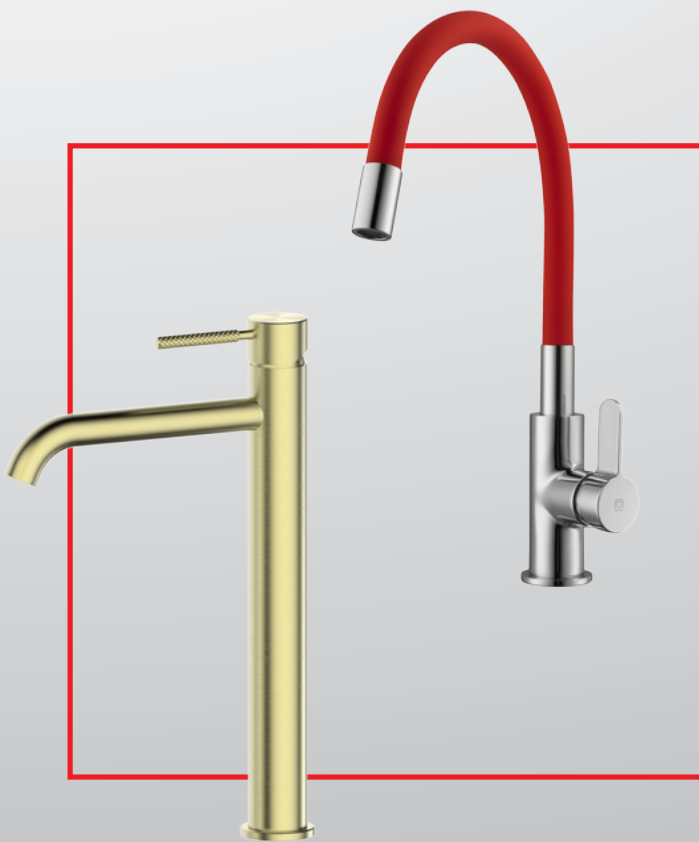

## 4 - 16



STAINLESS STEEL LUMA	4
ELITE SHOWER SYSTEM	5
CONCEALED SHOWER TAPS	6
BATHROOM ACCESSORIES	7
ELITE SLIM	8
ELITE KITCHEN	10
ELITE BATHROOM	12
LINO	14
SQ	16

## 20 - 47



 **Herz**<sup>®</sup>  
**UNITAS**<sup>®</sup>

Fulfilling Expectations.



European Company. Since 1933.

**NEW**



**Luma j12**



- 00620SS    00620BG
- 00620BC    00620GM



**Luma j10**



- 00610SS    00610BG
- 00610BC    00610GM



**Luma j50**



- 00510SS    00510BG
- 00510BC    00510GM



**Luma j30**



- 00310SS    00310BG
- 00310BC    00310GM



**Luma j40**



- 00410SS    00410BG
- 00410BC    00410GM



**Luma a320**

- 12070SS    12070BG
- 12070BC    12070GM



**Luma a620**

- 12010SS    12010BG
- 12010BC    12010GM



**Luma a820**

- 12170SS    12170BG
- 12170BC    12170GM



**Luma a520**

- 12670SS    12670BG
- 12670BC    12670GM



**Luma 16010**

- 16010SS    16010BG
- 16010BC    16010GM

# ELITE SHOWER SYSTEM

**NEW**



Shower system e193



00333



Shower system e193B



00333B



Shower system e193BG



00333BG

**NEW**





**Fresh termo f91**



00399



**Fresh termo f93 / f93B**



00400 00400B



**Push mix p93**



09420

# BATHROOM ACCESSORIES

**NEW**

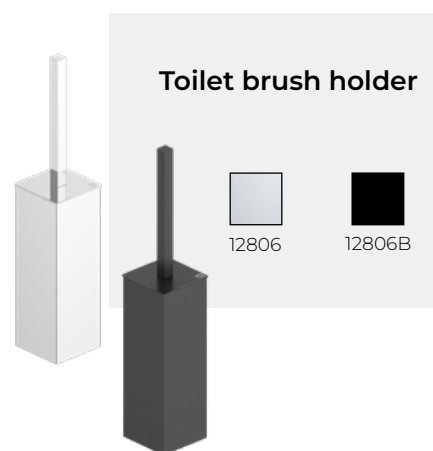
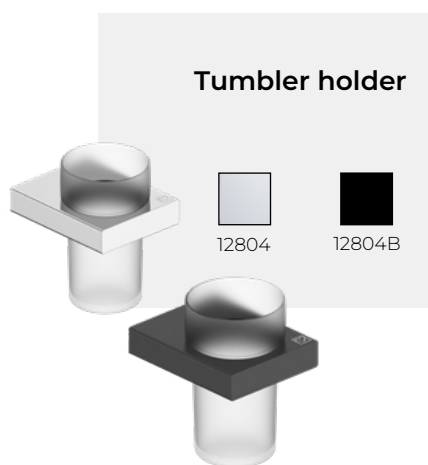
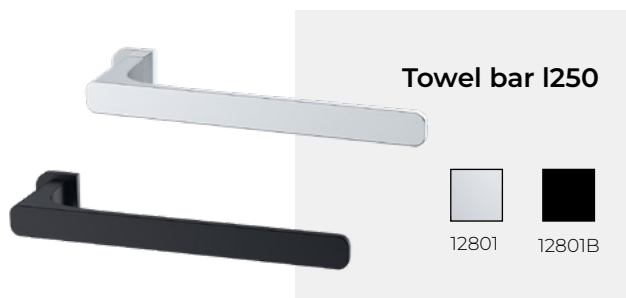











Elite e50B



00588B



Elite e11B



00088B



Elite e12B



00089B



Elite e50



00588



00586



Elite e11



00088



00086



00087



00085



Elite e12



00089



00079



00090



Elite e40B



00485B



Elite e30B



00373B



Elite e80B



00080B

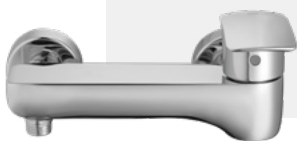

Elite e40



00485



00486



00487



Elite e30



00373



00374



000375



Elite e80



00080





Lino I12



00096



Lino I11



00095



00078



Lino I50



00590



Lino I90



12268



Lino I91



12269



Lino I40



00490

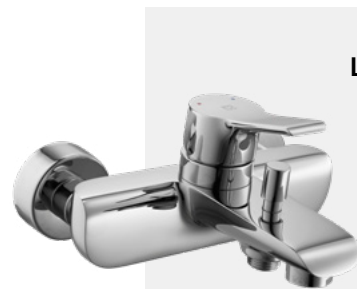

Lino I30



00396





SQ q12B



00058B



SQ q50B



000595B



SQ q11B



00057B

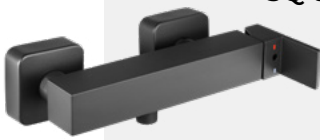

SQ q40B



000494B

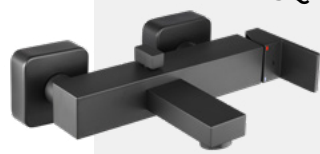

SQ q30B



000360B



SQ q12



00058



SQ q50



000595



SQ q11



00057



SQ q40



000494



SQ q30



000360

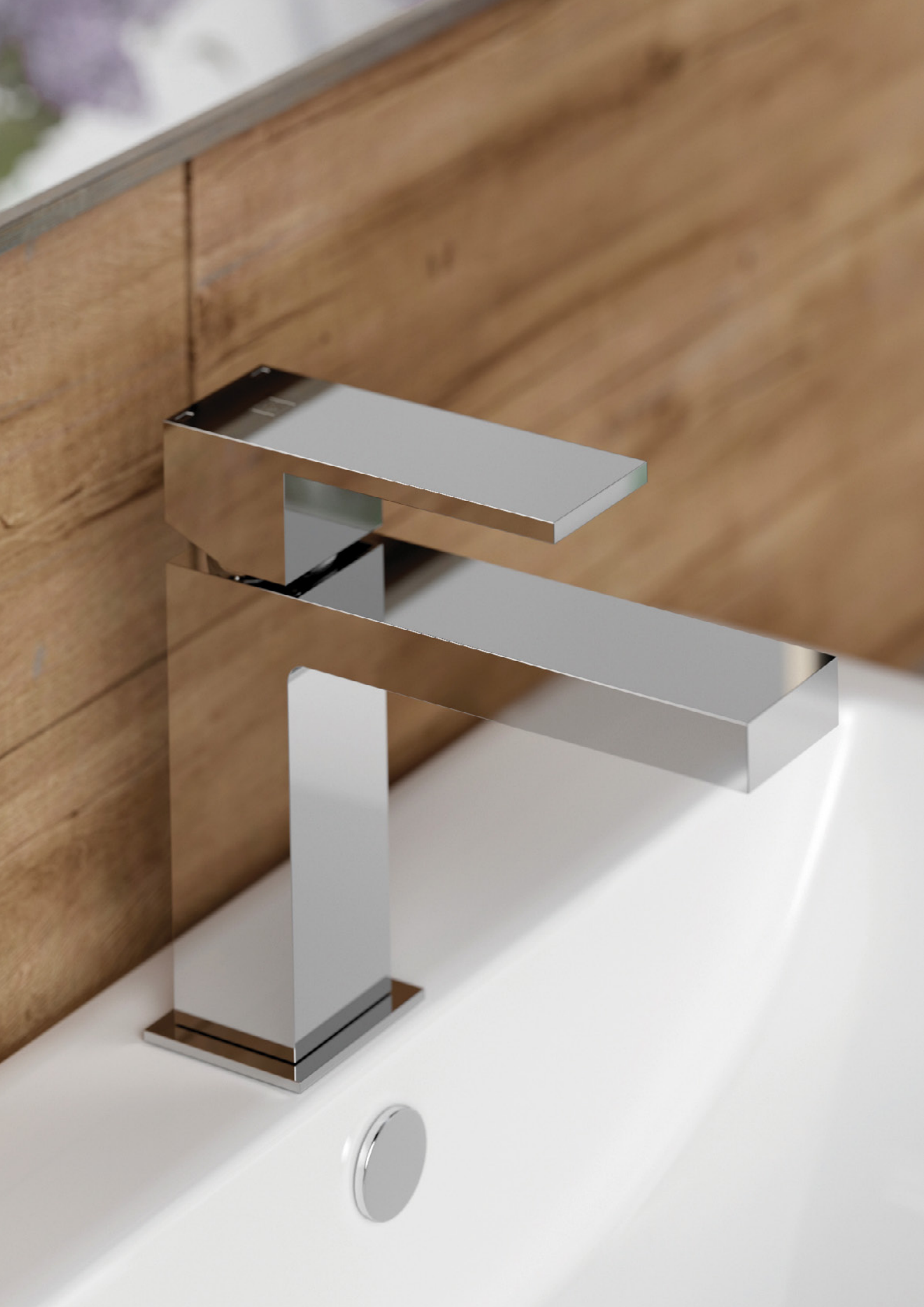

## 4 - 16

---



## 20 - 43

---



MULTIPOINT BALL VALVE	20
HERZ THERMIQ	22
AUTOMATIC FILLING VALVE	26
ZONE VALVE	27
HERZMAG	28
HERZMAG PRO	29
TMV	30
FROSTGUARD	31
PUMP GROUP SMARTCONTROL	32
PUMPFIX COMPACT DN20	33
PUMP GROUP	34
PUMPFIX SOLAR	36
HERZSOL	37
PUMP GROUP THERMO	38
BALL VALVES	39
STAINLESS STEEL MANIFOLDS	40
COMPOSITE MANIFOLDS	41
FLANGE VALVES	42
SAFETY VALVES	43

## 44 - 47

---

PRESSURE REDUCING VALVES	44
ANGLE VALVES	45
SANITARY MANIFOLDS	46
GARDEN VALVES	47



Fulfilling Expectations.



European Company. Since 1951.



# MULTIPOINT Ball valve



DN

DN15-DN32

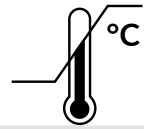

0,5 - 110°C

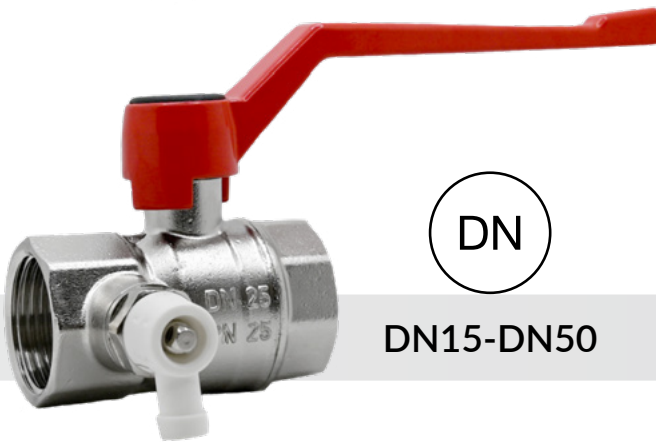

DN

DN15-DN50



PN25

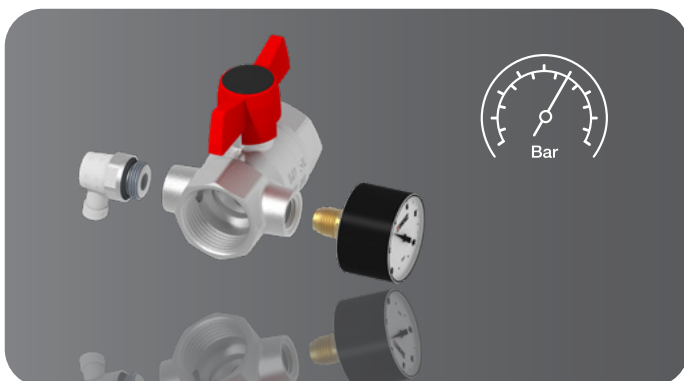
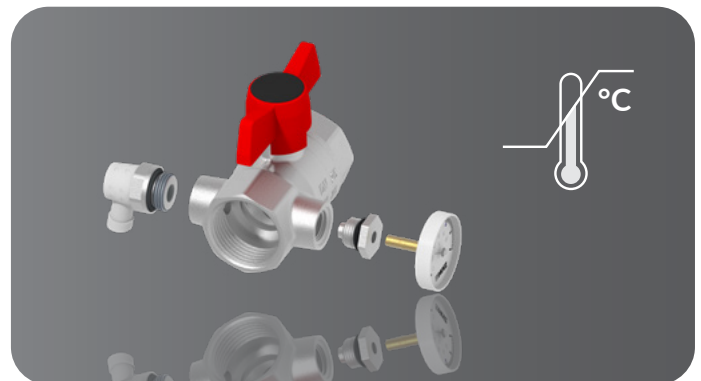
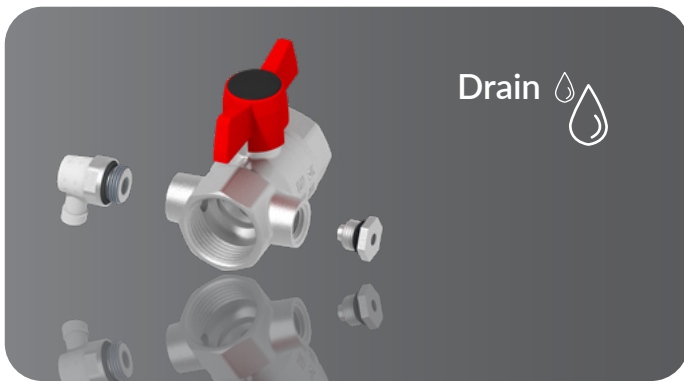



**NEW**

# MULTIPORT Ball valve

## Options

A) Ball valve with drain valve (long and short handle).

DN15-DN25



DN32-DN50



B) Ball valve with drain valve extended version (long and short handle).

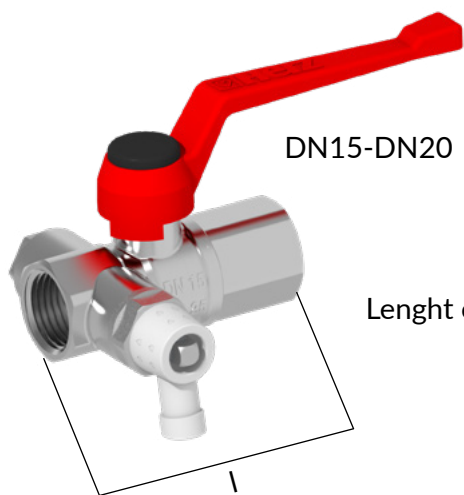

DN15-DN20

Length of the valve is the same like KV 402 / KV 403 version.

C) Ball valve with drain valve and M10 connection

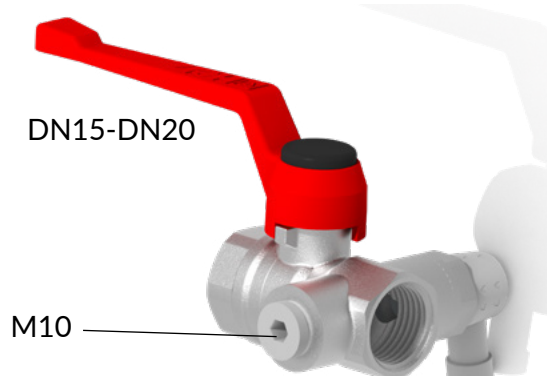

DN15-DN20

M10



**HERZ Thermiq**  
technological heart of your home

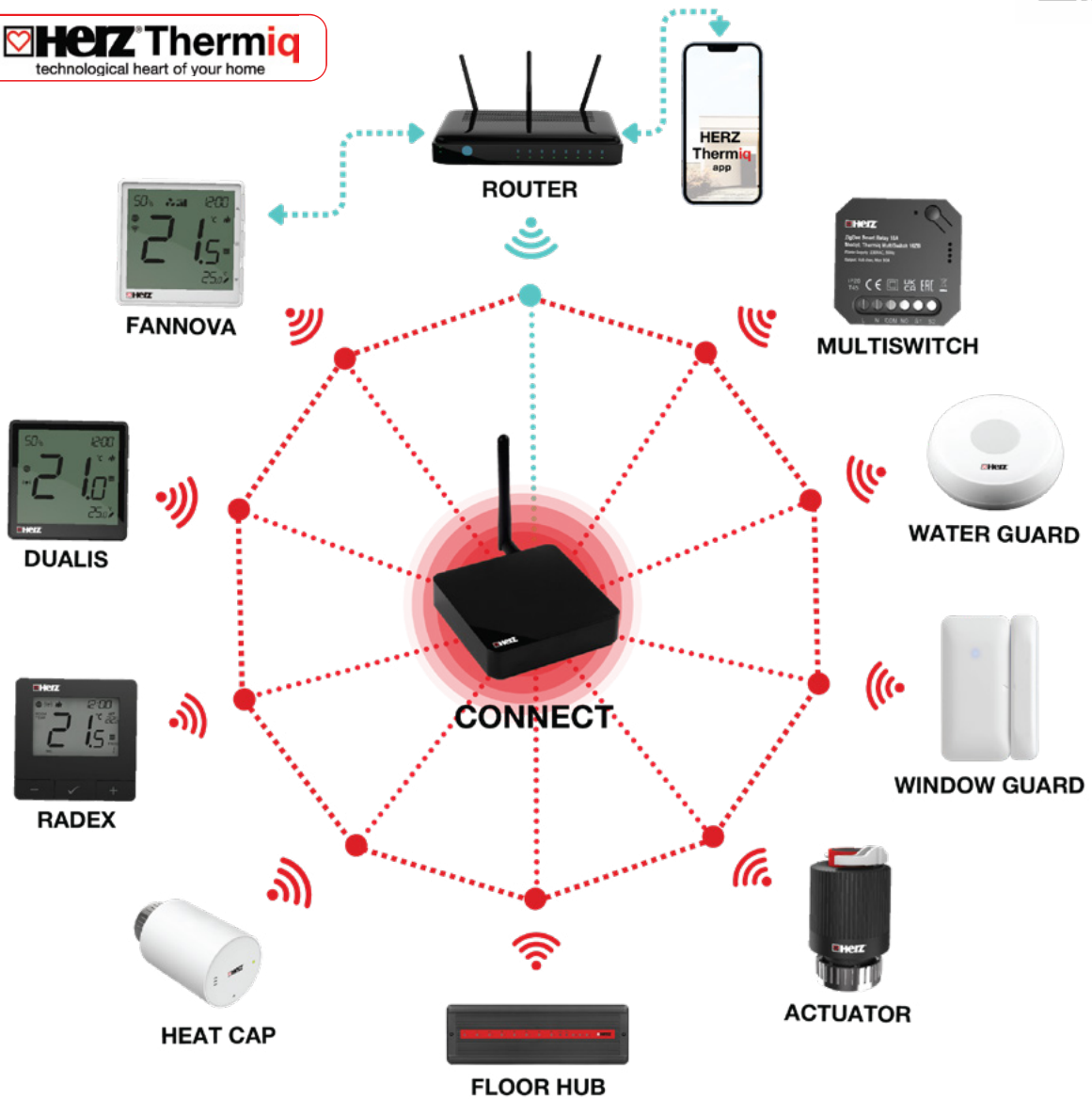

**HERZ Thermiq**

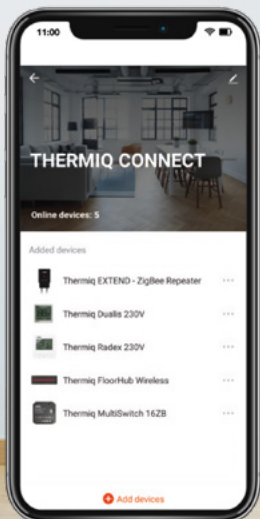

works with  
**Google Assistant**

WORKS WITH  
**amazon alexa**



Download on the  
**App Store**

ANDROID APP ON  
**Google play**



**NEW**



## HERZ THERMIQ FANNOVA

Used for:

- Fan Coil - 2/4 pipe system
- Underfloor heating

WiFi, 230V

- 3 F820 41 – BLACK edition
- 3 F820 42 – WHITE edition



## HERZ THERMIQ DUALIS

Used for underfloor heating

ZigBee, 230V

- 3 F820 21 – BLACK edition
- 3 F820 22 – WHITE edition



## HERZ THERMIQ RADEX

Used for:

- Radiator system
- Underfloor heating

Zigbee, 230V

- 3 F820 31 – BLACK edition
- 3 F820 32 – WHITE edition





### HERZ THERMIQ CONNECT

Smart Internet Gateway

ZigBee, WiFi, 230V  
3 F820 71



### HERZ THERMIQ FLOORHUB

Control Box for Underfloor Heating System

3 F820 11 – Wireless connectivity (6 wireless ZigBee zones + 2 wired zones, 230V)  
3 F820 12 – Wired connectivity (6 wired zones, 230V)



### HERZ THERMIQ ACTUATOR

Used for underfloor heating

230V, NC  
3 F820 51 – M28x1,5  
3 F820 52 – M30x1,5



### HERZ THERMIQ ACTUATOR

Thermostatic radiator head

White, battery powered  
3 F820 58 – M28x1,5





**NEW**



### HERZ THERMIQ MULTISWITCH

Smart Relay

1x16A, NO-COM output, 230V  
3 F820 65 – ZigBee connectivity  
3 F820 66 – WiFi connectivity



### HERZ THERMIQ WATERGUARD

Water leak sensor

Zigbee  
3 F820 67



### HERZ THERMIQ EXTEND

Repeater, increases the wireless range

3 F820 76 – Modular  
3 F820 75 – Socket



### HERZ THERMIQ HEATGUARD

Temperature Sensor

Suitable for installation in the floor  
3 F208 61



### HERZ THERMIQ WINDOWGUARD

Door / window Sensor

3 F820 68





# Automatic filling valve

- Installed in the water supply piping of closed heating systems
- Maintain a stable system pressure at a pre-set value

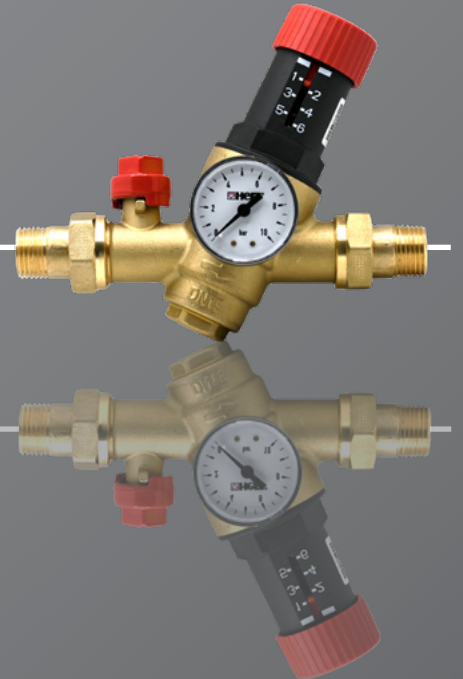

DN15



PN16

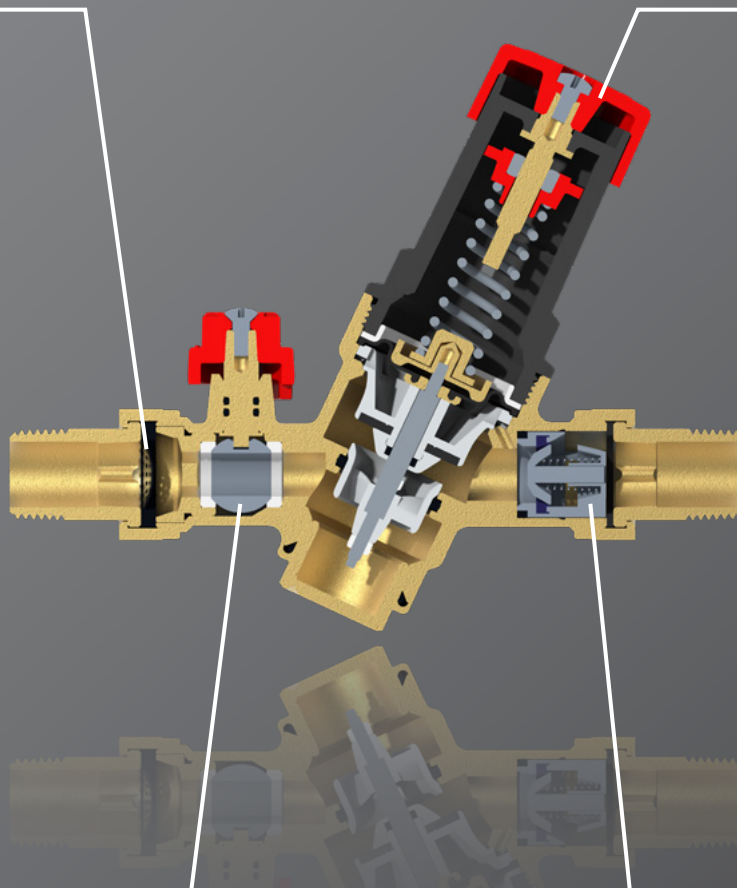
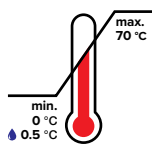



# Zone valve



Quick response, energy efficiency



Tailored to your needs



Uncompromising quality



Versatile sizing

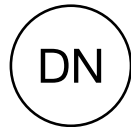

DN20-DN32



PN10

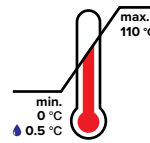

min. 0 °C  
max. 110 °C  
0.5 °C



Compression ends

DN20  
Cu22

DN25  
Cu28

DN32  
Cu35



External thread

DN20  
G 3/4"

DN25  
1"

DN32  
G 1-1/4"

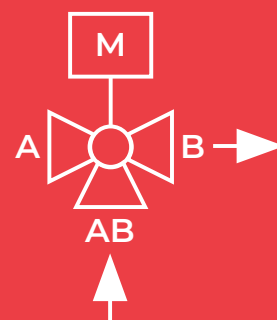
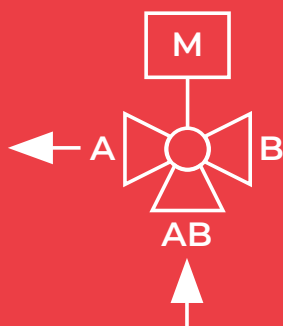



# HerzMAG



**DN**  
DN20-DN25

**Bar**  
PN3

min. 0.5 °C  
max. 90 °C



T piece with 360 degree adjustment



Internal element with mesh and air vent

Nr.	DN	☒
1 1124 12	DN20	No
1 1301 02	DN20	Yes
1 1124 13	DN25	No
1 1301 03	DN25	Yes



Rotatable connector



Magnets



Drain valve

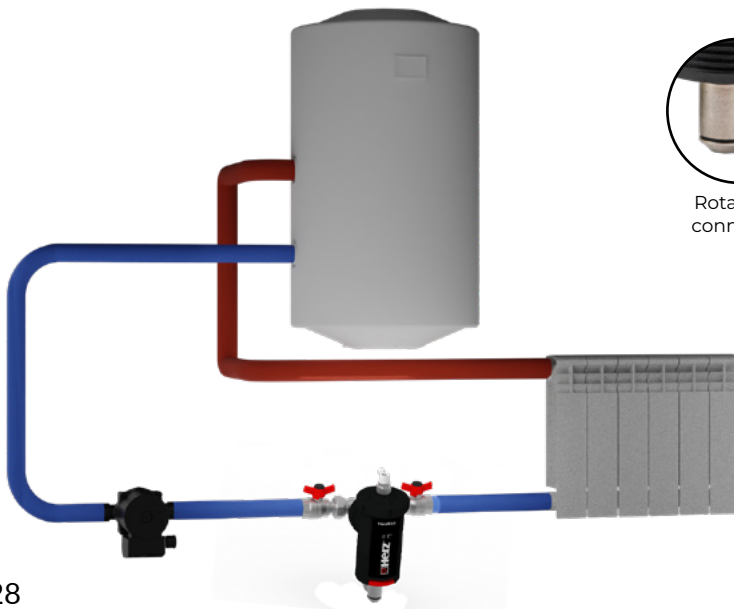



NEW



# HerzMAG PRO

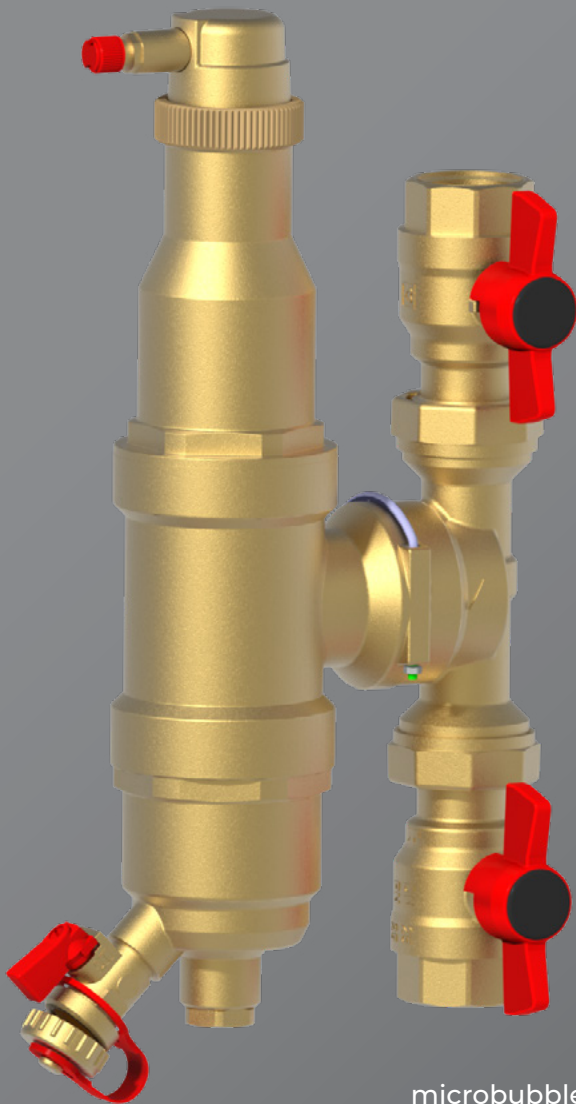

Technical specifications:

- DN: DN20-DN25
- Pressure: PN10
- Temperature range: min. -10 °C, max. 90 °C

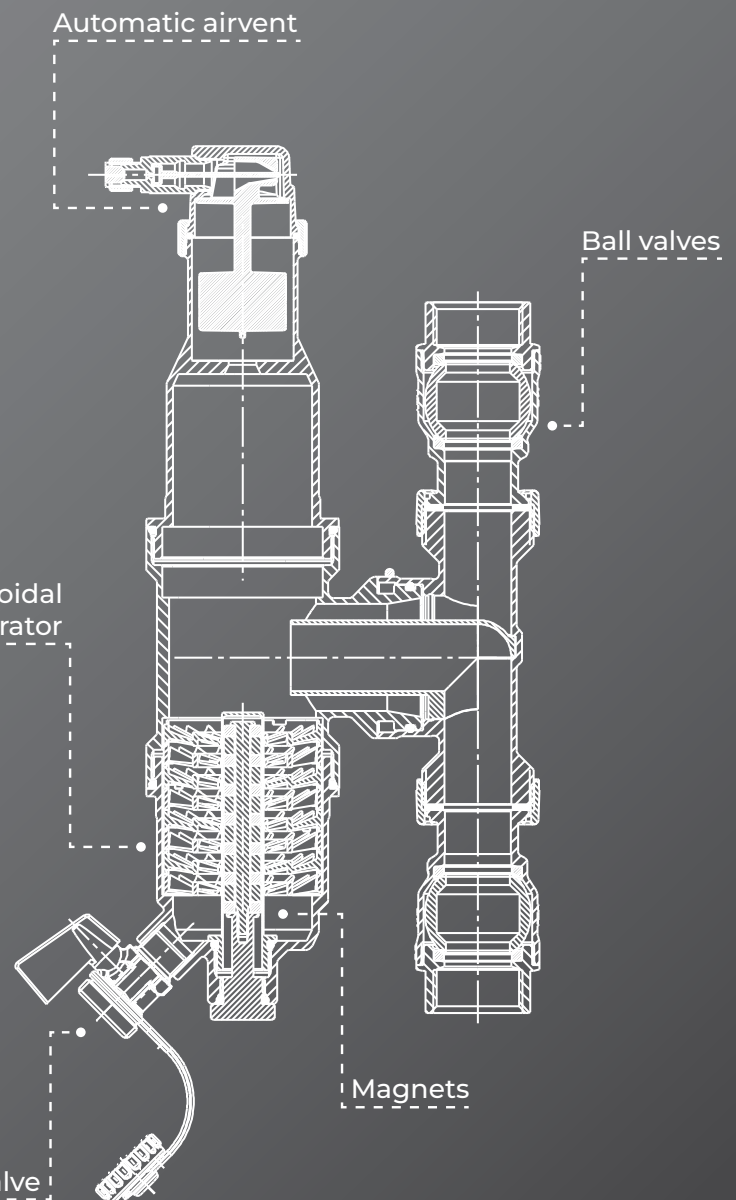

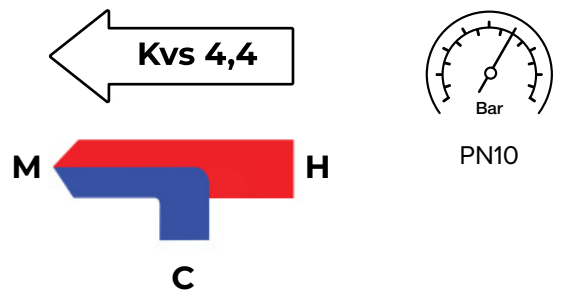
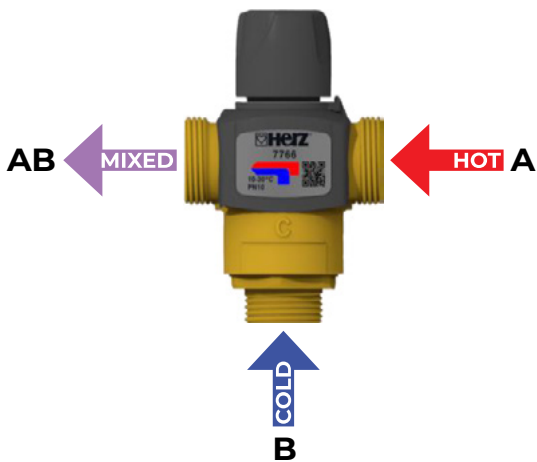

**Heat pump - cooling**

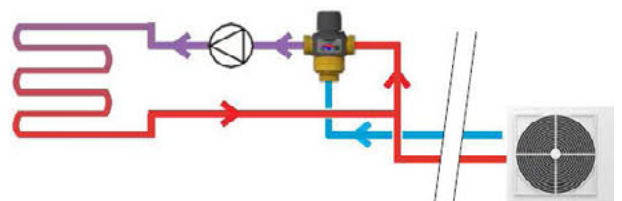

10 - 30 °C	Heat pump - cooling
20 - 45 °C	Floor heating
45 - 70 °C	Radiator heating

**Floor heating**

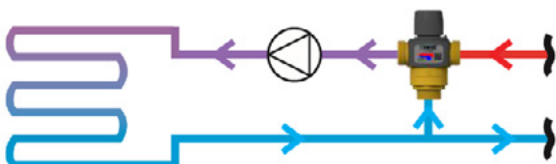

**Radiator heating**

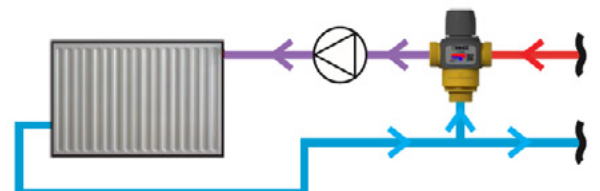



# FrostGuard

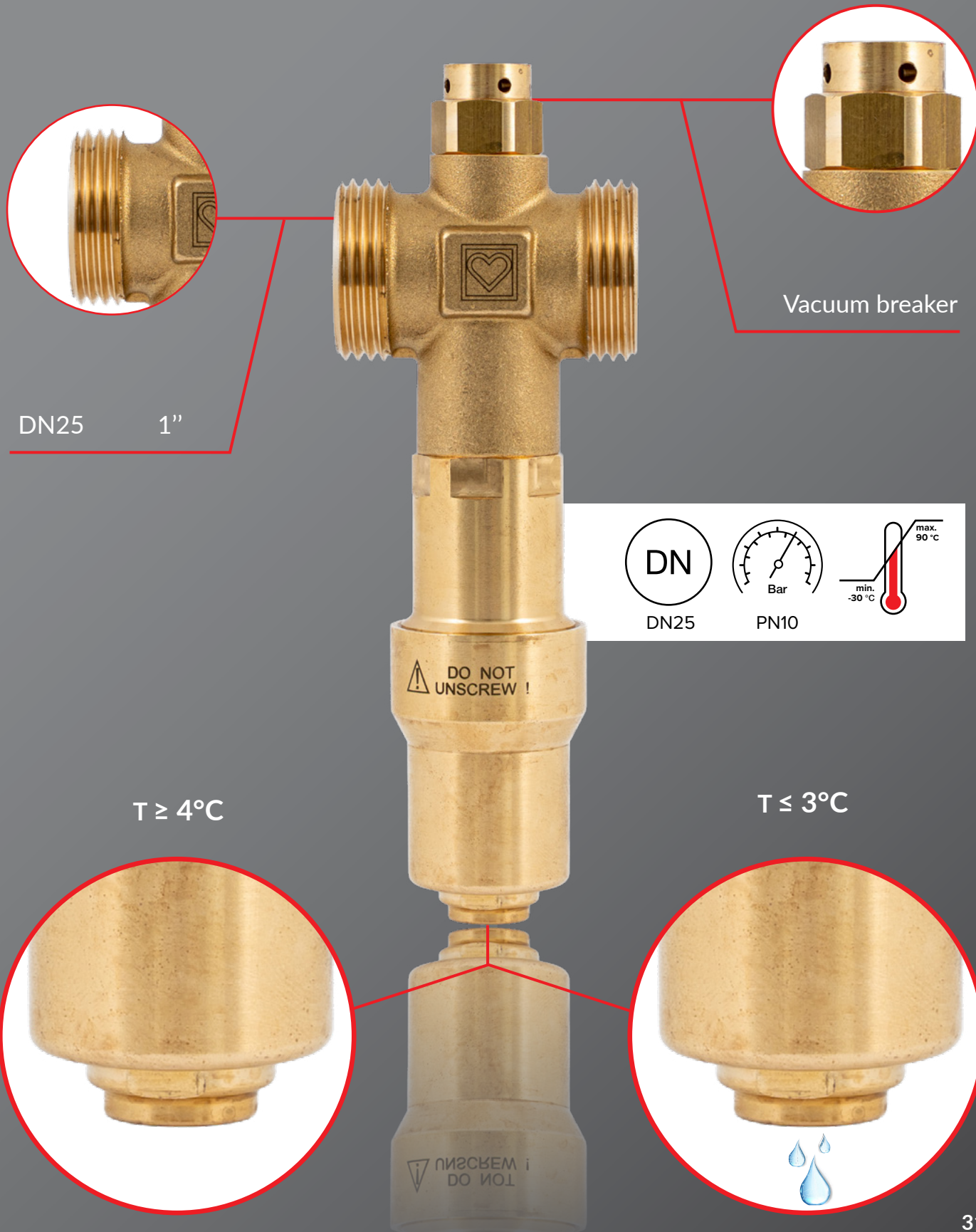



# Pump group Smartcontrol

- Combining motor drive and controller in a single unit.
- No additional regulator needed - simple installation and reducing costs.

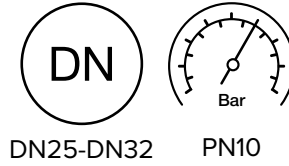

## PUMPFIX SMARTCONTROL

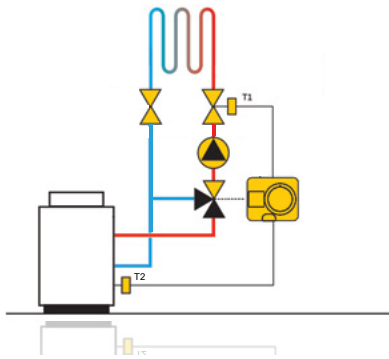

Clutch for manual operation



Setting keys



## PUMPFIX SMARTCONTROL PLUS

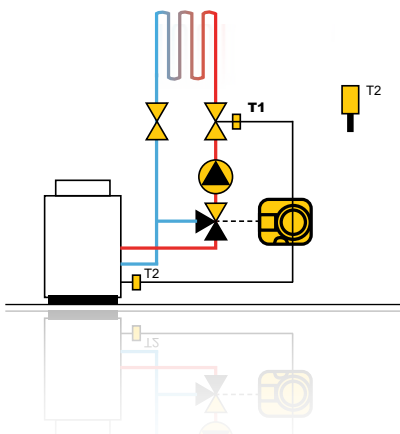

Plug-in connectors



## EUROMIX SMARTCONTROL

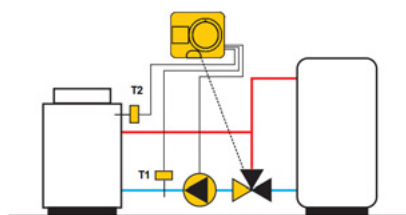

Graphic display

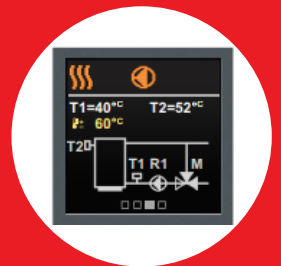



**NEW**



# Pumpfix COMPACT DN20



Ball valve with thermometer and check valve

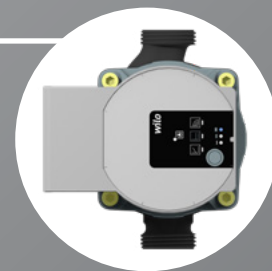

Wilo pump

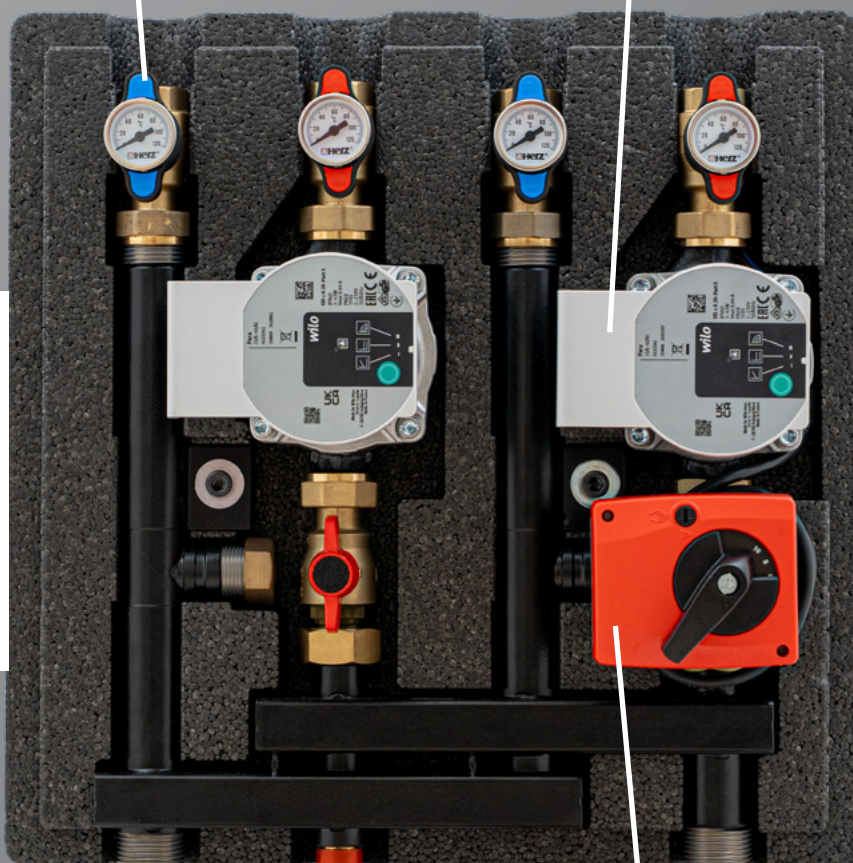

DN  
DN20



Bar  
PN4

Dimensions:  
410 x 410mm



Control knob for hydraulic switch

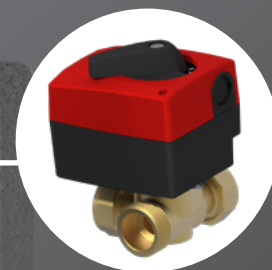

Three-way mixing valve + actuator



 **Pump group**

BRASS

STEEL

**Pumpfix  
DIRECT  
DN20 - DN32**



**Pumpfix  
MIX  
DN20 - DN32**



**Pumpfix  
CONSTANT  
DN25**



# Pump group



**PF 4011  
PF 5011**  
DN40 - DN50



**PF 4001  
PF 5001**  
DN40 - DN50

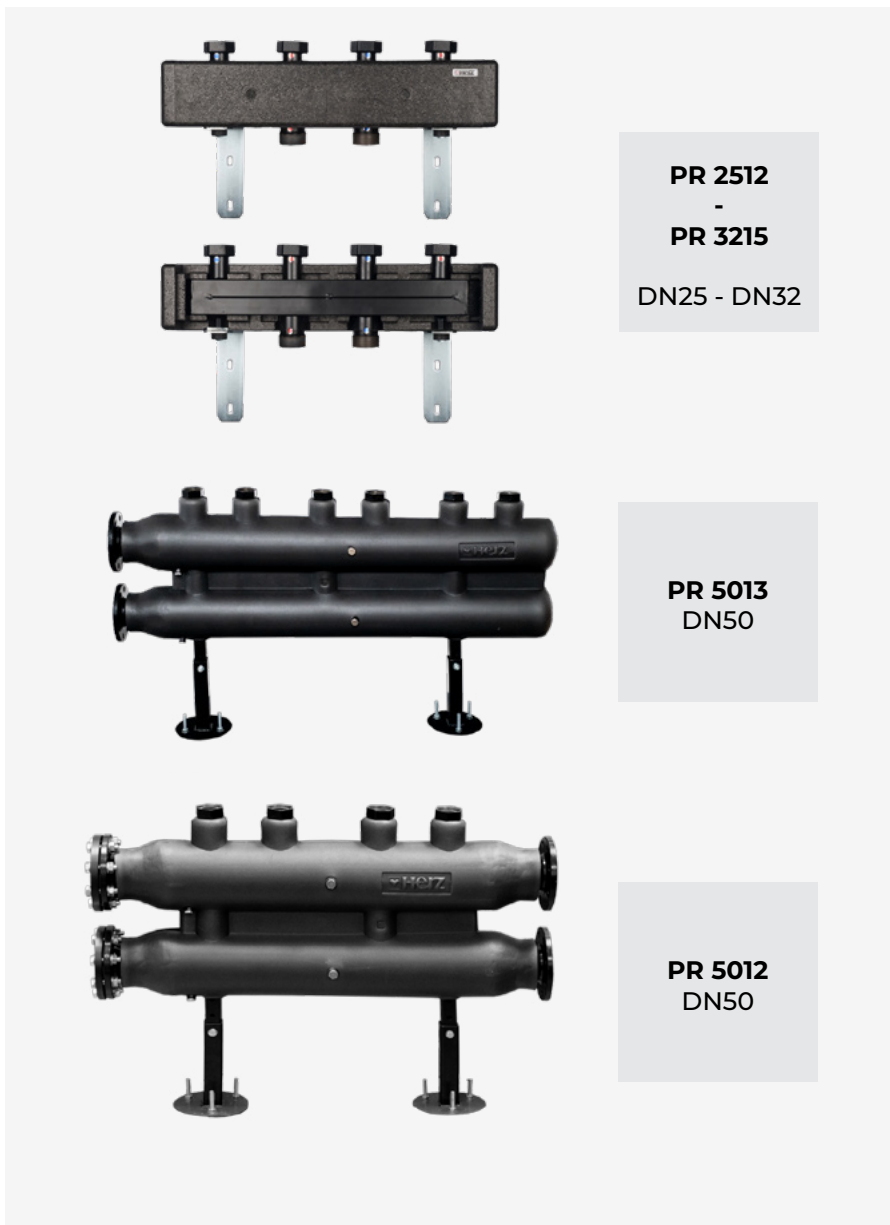

**PR 2512  
-  
PR 3215**  
DN25 - DN32

**PR 5013**  
DN50

**PR 5012**  
DN50

 **Pumpfix SOLAR**

**Pumpfix  
SOLAR DN20**

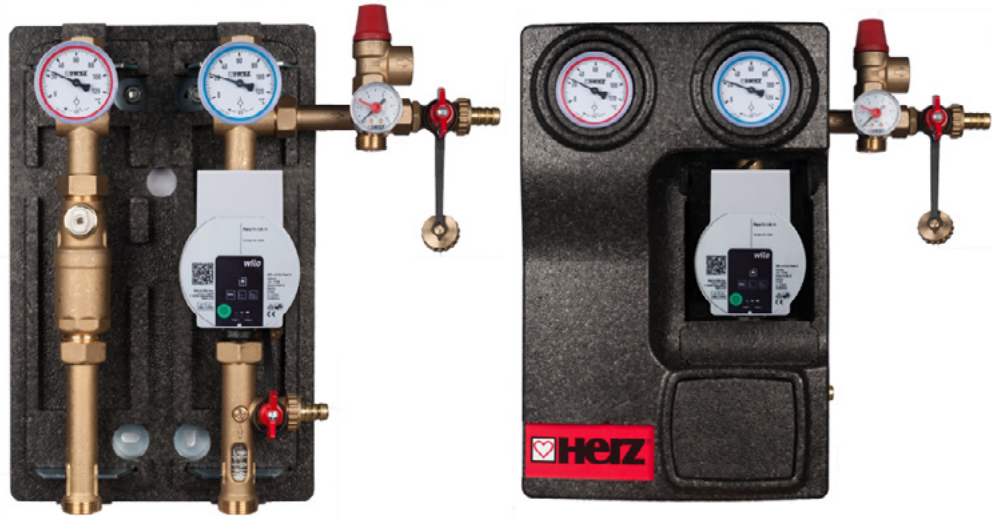

**Pumpfix  
SOLAR  
SIMPLE DN20**

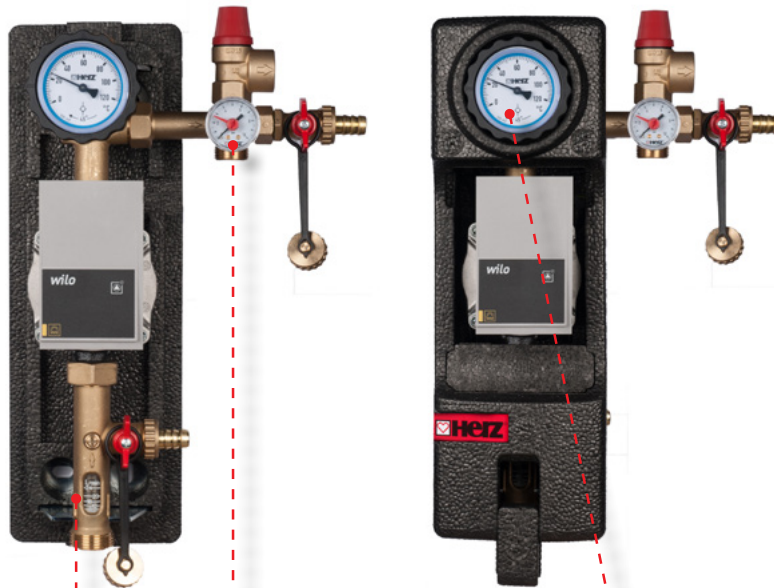

FLOW METER



SAFETY GROUP



INTEGRATED BALL WITH  
NON-RETURN INSERT





**NEW**



**HerzSol**

**Display:**

128 x 64 px  
monochrome



**Power supply:**

230 V AC (50 Hz)

**AI:**

5 x Pt1000  
1 x 0-10 V  
1 x 4-20 mA

**AO:**

1 x 0-10 V

**DO:**

1 x PWM

**DI:** 4 x optical isolated

**DO:** 4 x Triac (16 A)  
2 x Relay (16 A)

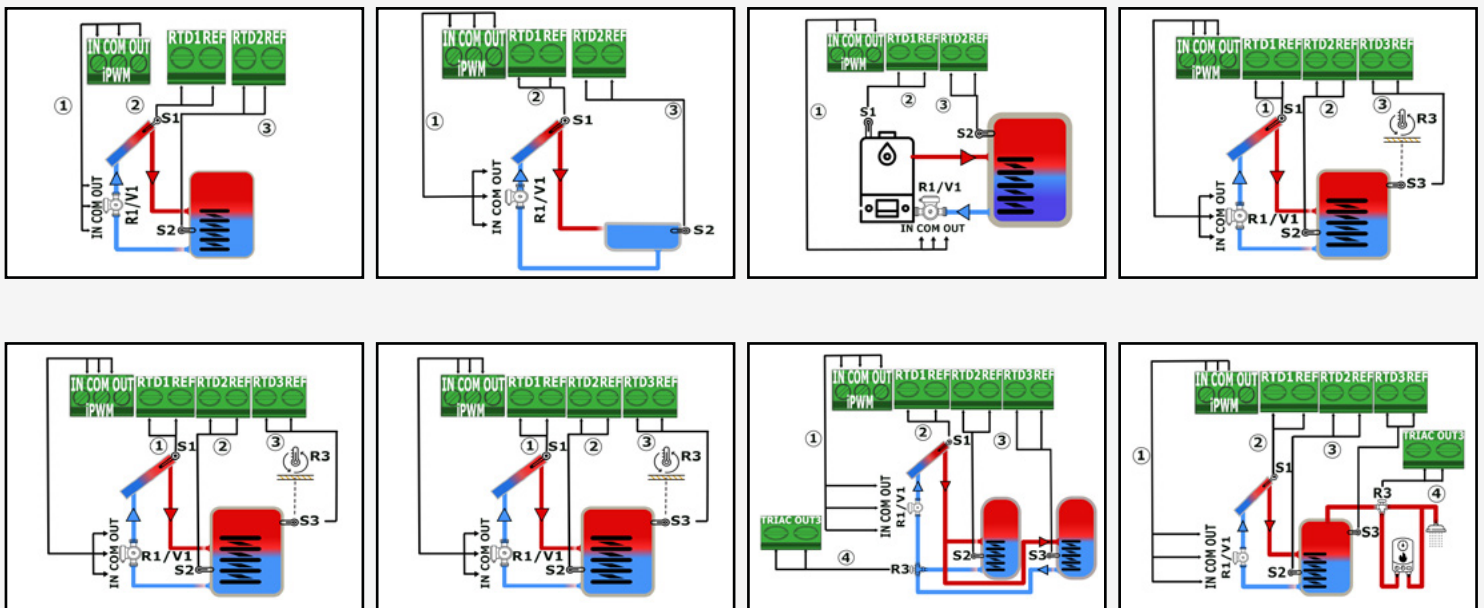

And more...

 **Pump group THERMO**

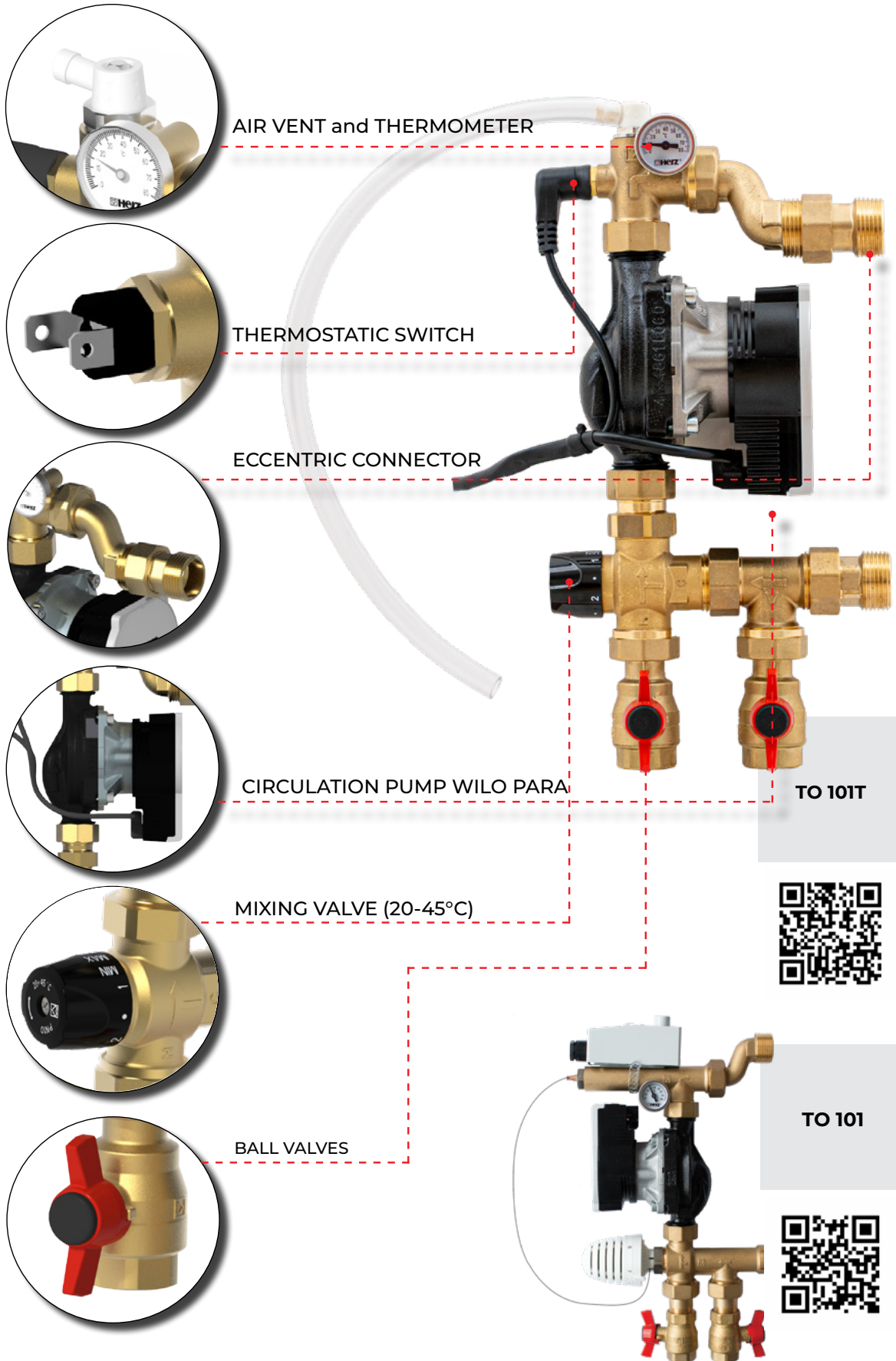

AIR VENT and THERMOMETER

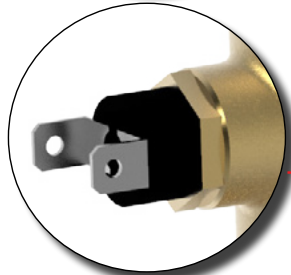

THERMOSTATIC SWITCH



ECCENTRIC CONNECTOR

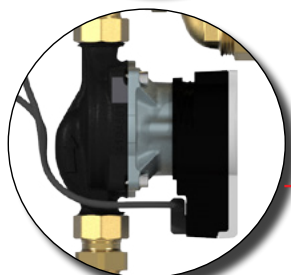

CIRCULATION PUMP WILO PARA

TO 101T



PN6



MIXING VALVE (20-45°C)

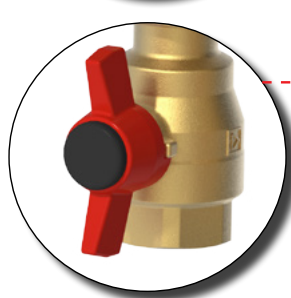
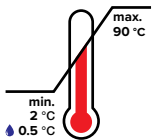

BALL VALVES

TO 101

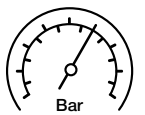

PN6

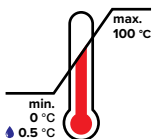

# Ball valves

## HEAVY TYPE

KV 100  
-  
KV 109  
DN8-DN80

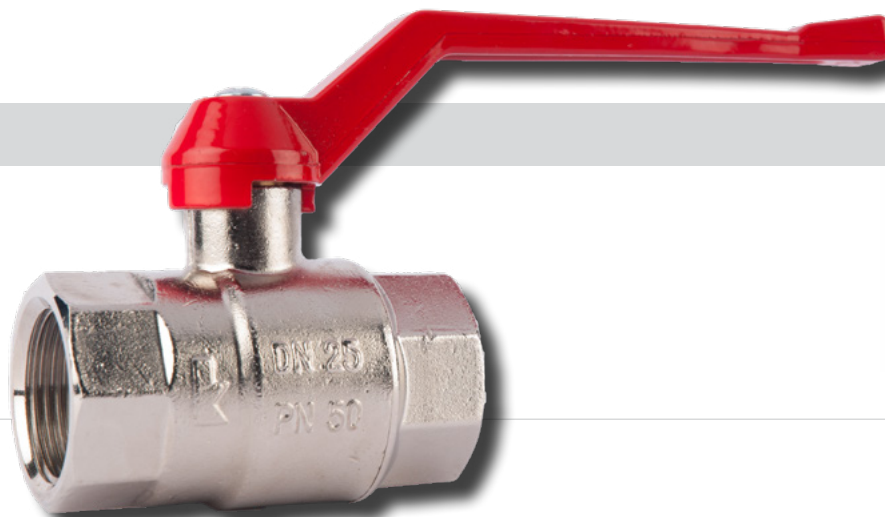

## MODUL

KV 2102  
-  
KV 2107  
DN15-DN50

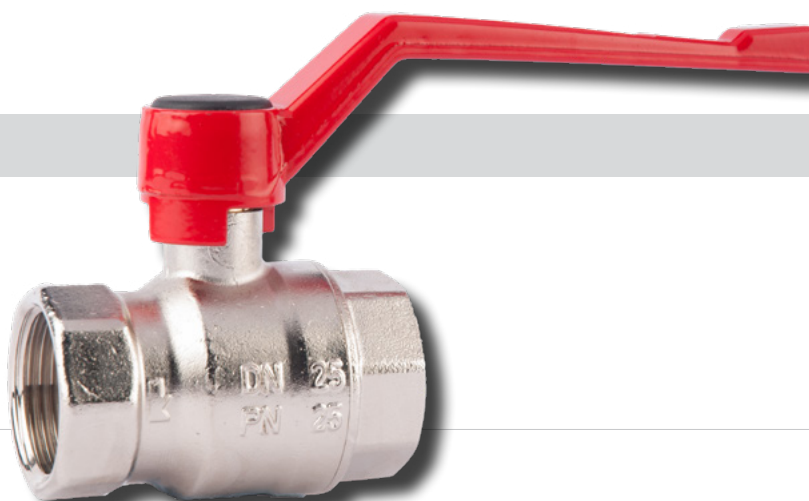

## CLASSIC

KV 97X  
-  
KV 99X  
DN15-DN50

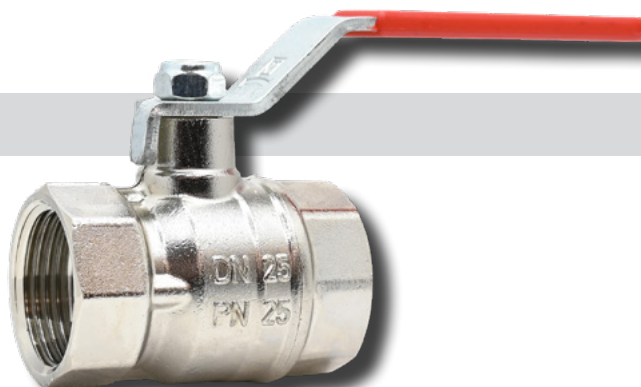



# Stainless steel manifolds

## HERZ STANDARD

TO 103  
-  
TO 112

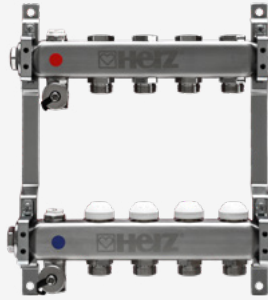

TO 203  
-  
TO 212

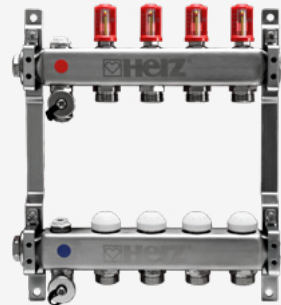

TO 403  
-  
TO 412



TO 303  
-  
TO 312

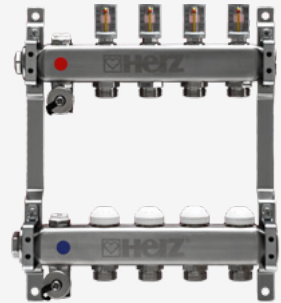

TO 202A  
-  
TO 216A



TO 302A  
-  
TO 316A

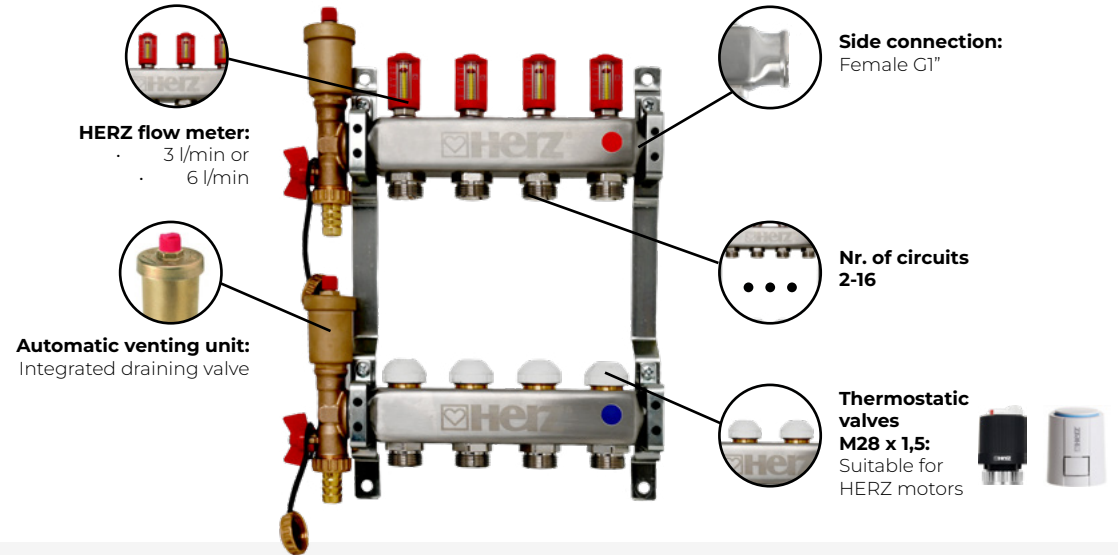

## OEM VERSIONS:

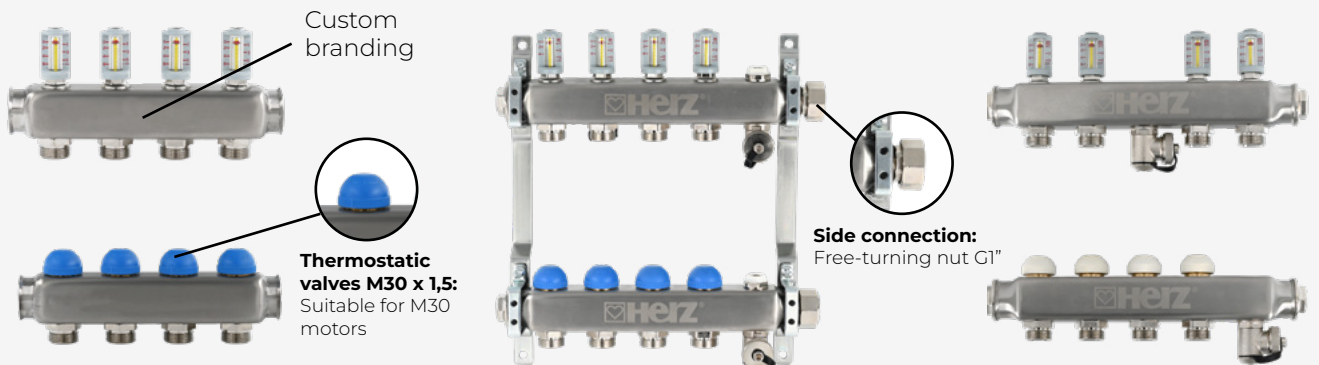

# Composite manifolds

## HERZ STANDARD

Side connections: Male 1-1/2"

Eurocone G3/4"

UNI - MULTI 2,4l/min

UNI - MULTI 8l/min

Nr. of circuits 2-16

2,4 l/min or 8 l/min

Side connections: Male 1-1/2"

Eurocone G3/4"

Side connections: Male 1-1/2"

Push fit: 16mm

UNI - TOP 2010M 2,4l/min

UNI - TOP 2010/16 2,4l/min

UNI - TOP 2010M 8l/min

UNI - TOP 2010/16 8l/min

Nr. of circuits 2-16

2,4 l/min or 8 l/min

Nr. of circuits 2-16

2,4 l/min or 8 l/min

## OEM VERSIONS:

- Ball valve G1 - G1-1/2
- Thermometer 0°C - 60°C

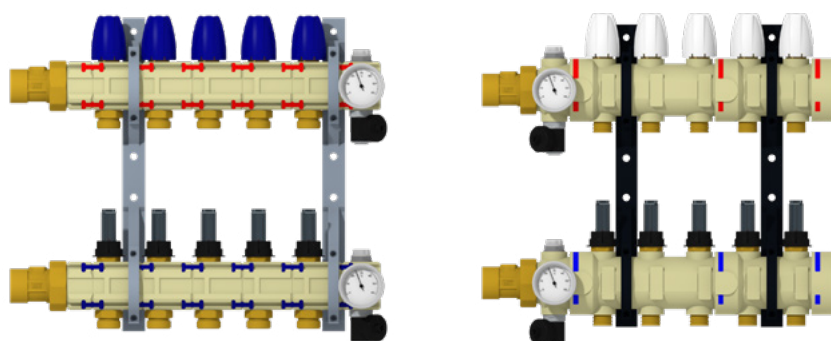



# Flanged valves

## Butterfly valves

**1 4219 xx**

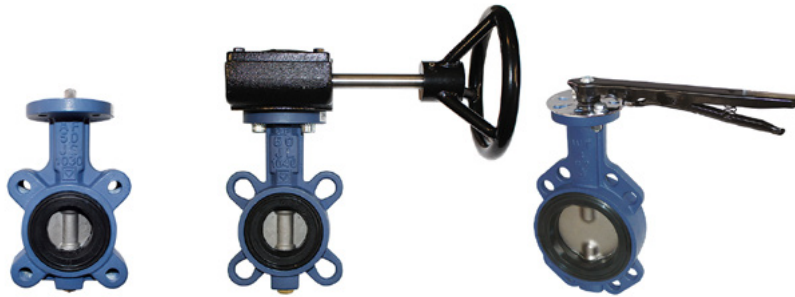
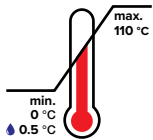

Waffer type or  
Lugged type  
DN50 - DN300

## Stromax GMF

**1 4218 xx**

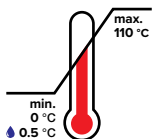

DN25-DN150

## Stromax GF

**1 4218 8x**

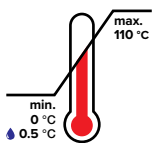

DN50-DN300

## Check valve

**3 2622 xx**

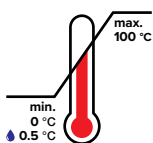

DN40-DN300

# Safety valves

## Airvent VO 628 VO 630

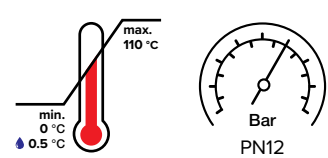

G 3/8" - G 3/8"  
G 3/8" - G 1/2"

## Check valve VP 642 VP 647

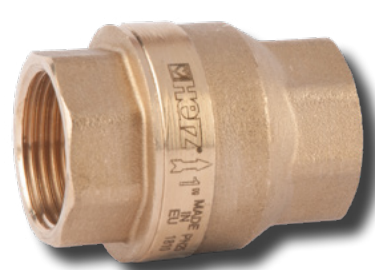
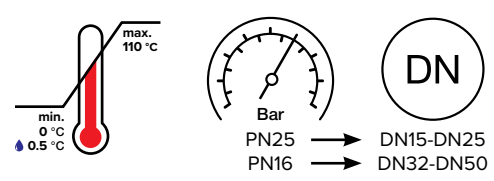

## Airvent MICRO 1 2630 38

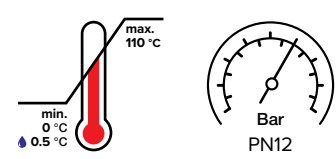

G 3/8" - G 1/2"

## Pressure relief valve VV611 VV697



CE



# Pressure reducing valves

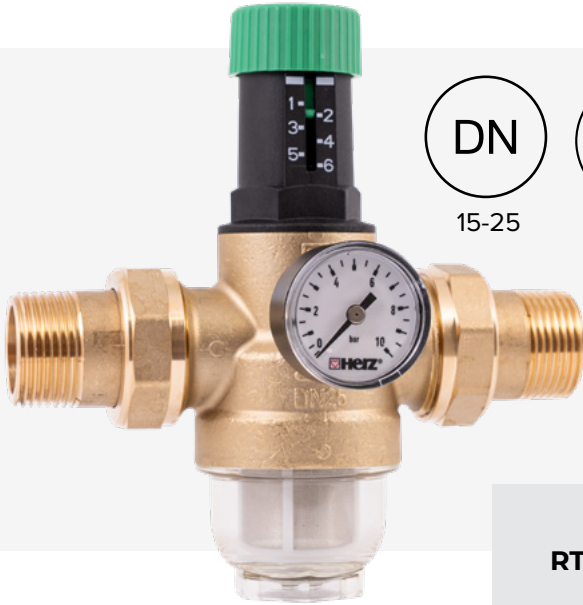

DN  
15-25

Bar  
PN16

min. 0 °C  
max. 40 °C  
0.5 °C

RT 692  
-  
RT 694



RTF 692  
-  
RTF 697



RT 695  
-  
RT 697

DN  
DN32-DN50

Bar  
PN16

min. 0 °C  
max. 40 °C  
0.5 °C





# Angle valves

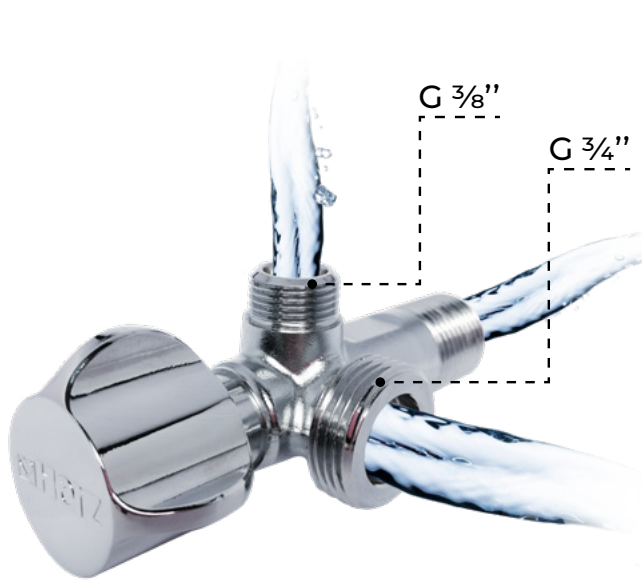

**KV 555**



**KV 556**

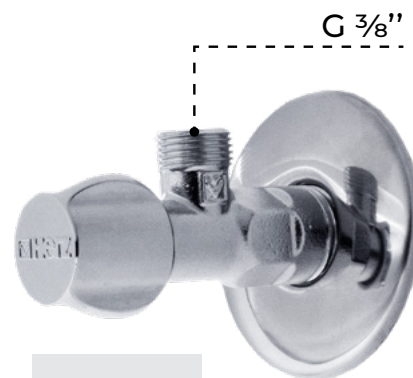

**KV 557**

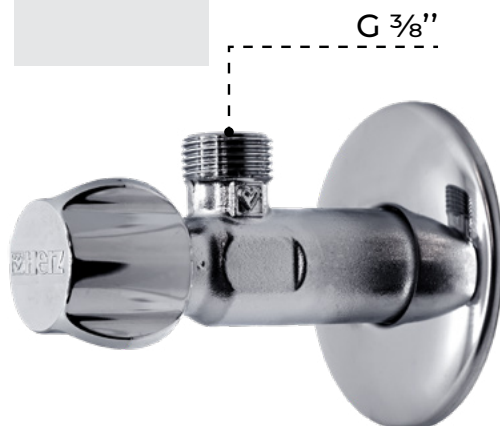

**LONG  
KV 559**

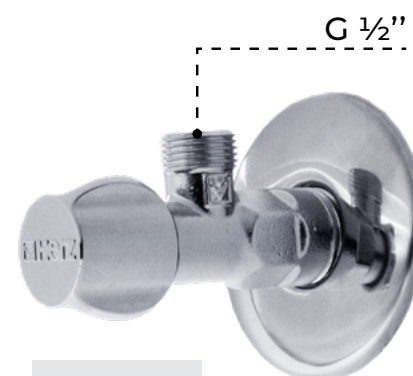

**KV 558**

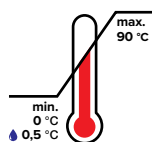

PN16



**Sanitary manifolds**

**DN20:**  
RSV 102  
-  
RSV 104



**Nr. of circuits:**  
2-4



**DN25:**  
RSV 113  
-  
RSV 115



**Nr. of circuits:**  
3-5

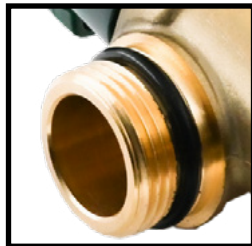
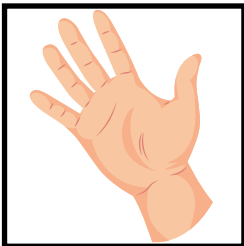

**DN**  
DN20-DN25

**Bar**  
PN10

**max. 110 °C**  
**min. 0 °C**  
**0.5 °C**

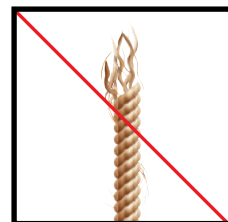
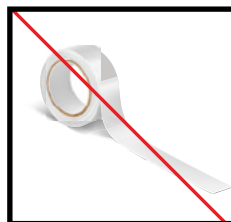
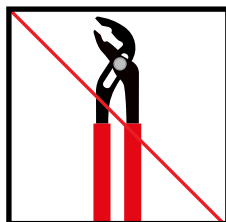
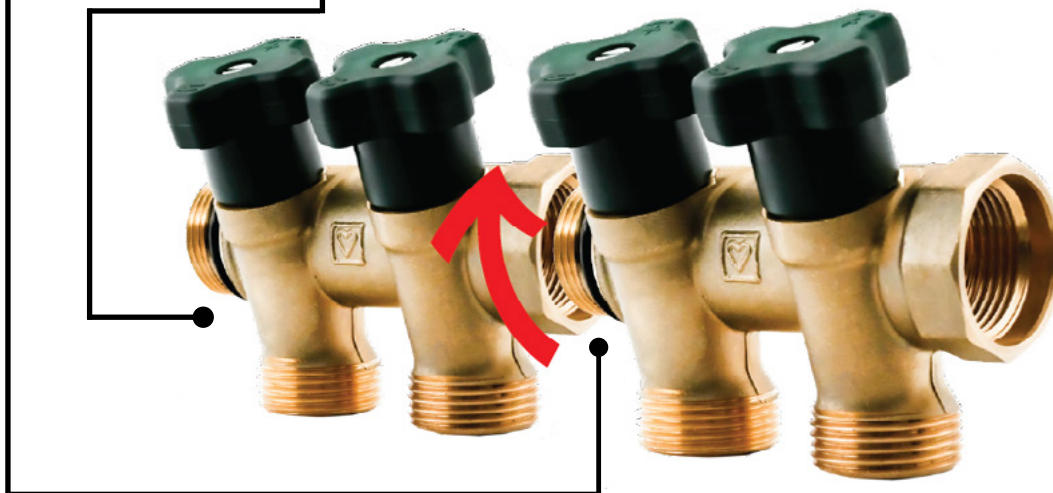



## Garden valves



KP 532  
-  
KP 533



KP 532M  
-  
KP 533M



KP 502  
-  
KP 503



KP 502G M  
-  
KP 503G M



KP 510M  
-  
KP 522M



**HERZ d.o.o.**

Grmaška cesta 3  
1275 Šmartno pri Litiji  
T: +386 (0)1 896 21 02  
F: +386 (0)1 896 21 40  
E: [info@herz.si](mailto:info@herz.si)  
W: [www.herz.si](http://www.herz.si)

